



Атмосфера вашої оселі

# Hisense

## USE AND INSTALLATION INSTRUCTIONS

### Моделі

GMZ2-14H-S

GMZ2-18H-S

### Важлива інформація

Модель	Живлення подається на зовнішній блок	Кабель, мм <sup>2</sup>	Міжблочний кабель, мм <sup>2</sup>
GMZ2-14H-S	1 фаза, 220-240 В, 50 Гц	3x2,5	4x1,5
GMZ2-18H-S	1 фаза, 220-240 В, 50 Гц	3x2,5	4x1,5

Thank you very much for purchasing this Air Conditioner. Please read this use and installation instructions carefully before installing and using this appliance and keep this manual for future reference.



# Contents

<b>safety instructions</b> .....	<b>1</b>
<b>Refrigerant flow diagram</b> .....	<b>3</b>
<b>Installation instruction</b> .....	<b>4</b>
Installation diagram .....	4
Transportation and handing before installation .....	5
Select the installation locations .....	5
Install drainage elbow and drain hose .....	5
Outdoor installation .....	6
Refrigerant piping.....	6
Wiring .....	9
Trial run .....	11

# Safety precautions

1. This air conditioner uses new refrigerant HFC(R410A).
2. Since the max. working pressure is 4.15MPa(R22:3.1MPa),some of the piping and installation and service tools are special.
3. This air conditioner uses power supply: 220-240V ~,50Hz.

## Please read these SAFETY PRECAUTIONS carefully to ensure correct installation.

- Be sure to use a dedicated power circuit, and do not put other loads on the power supply.
- Be sure to read these SAFETY PRECAUTIONS carefully before installation.
- Be sure to comply with SAFETY PRECAUTIONS of installation manual, because it contains important safety issues. Definitions for identifying hazard levels are provide below with their respective safety symbols.
  - ⚠ WARNING: Hazards or unsafe practices which COULD result in severe personal injury or death.
  - ⚠ CAUTION: Hazards or unsafe practices which COULD result in minor personal injury or product or property damage.
- Please carefully file indoor and outdoor unit manual away for future reference.



- Installation should be left to the professionals, do not do it by you(customer).  
Incomplete installation could cause damage by fire, electric shock, drop or water leakage.  
Please consult your dealer or professional installation personnel.
- Install the air conditioner on a solid base that can support the unit weight.  
An inadequate base or incomplete installation may cause injury in the event the unit falls off the base.
- Use the specified type of wire for electrical connections safely between the indoor and outdoor units.  
And firmly connected to the connection part of wire terminals, so that the wire stress will not be applied to these parts.  
Incomplete connection may cause fire.
- For wiring, use a cable long enough to cover the entire distance with no connection.  
And don't connect multiple devices to the same AC power supply.  
Otherwise, it may be due to bad contact, poor insulation, exceed the allowable current and cause a fire or electric shock.
- After all installation is complete, check to make sure that no refrigerant is leaking out.  
If the refrigerant gas leakage to the interior, and the heater, stove flame touching it, will generate harmful substances.
- Perform the installation securely referring to the installation manual.  
Incomplete installation could cause a personal injury due to fire, electric shock, the unit falling or leakage of water.
- In accordance with the installation instructions for electrical work, please be sure to use a dedicated line.
- If the power supply circuit capacity or electrical work is not in place, may cause a fire or electric shock.
- Attach the electrical cover to the indoor unit and the service panel to the outdoor unit securely.
- If the electrical covers on the indoor unit or the service panel of the outdoor unit are not attached securely, it could result in a fire or an electric shock due to dust water, etc.
- Please be sure to cut off the main power supply before the installation of indoor electronic PCB or wiring.  
Otherwise, it will cause electric shock.
- The device should be in accordance with the state provisions for installation wiring.
- The indoor appliance should be placed not in the children's height -- at least above ground 2.5m.
- The outdoor machine installation location should pay attention to the protection, avoid people or other small animals contact with electrical components, please keep the outdoor unit of the surrounding environment clean and tidy.
- When installing or relocating the unit, make sure that no substance other than the specified refrigerant (R410A) enters the refrigerant circuit.  
Any presence of foreign substance such as air can cause abnormal pressure rise or an explosion.

# Safety precautions



- Perform grounding  
Does not connect the earth wire to a gas pipe, water pipe, lightning rod or telephone earth wire. Defective grounding could cause an electric shock.
- Do not install the unit in a place where an inflammable gas leaks.  
If gas leaks and accumulates in the area surrounding the unit, it could cause an explosion.
- Fasten a flare nut with a torque wrench as specified in this manual.  
When fastened too tight, a flare nut may break after a long period and cause a leakage of refrigerant.
- Install an earth leakage breaker depending on the installation place (where it is humid).  
If an earth leakage breaker is not installed, it could cause an electric shock.
- Perform the drainage/piping work securely according to the installation manual.
- If there is a defect in the drainage/piping work, water could drop from the unit and household goods could be wet and damaged.

## Safety instructions

- Do not let air enter the refrigeration system or discharge refrigerant when moving the air conditioner.
- The installation instructions for appliances that are intended to be permanently connected to fixed wiring, and have a leakage current that may exceed 10 mA, shall state that the installation of a residual current device (RCD) having a rated residual operating current not exceeding 30 mA is advisable.
- This appliance can be used by children aged from 8 years and above and persons with reduced physical, sensory or mental capabilities or lack of experience and knowledge if they have been given supervision or instruction concerning use of the appliance in a safe way and understand the hazards involved. Children shall not play with the appliance. Cleaning and user maintenance shall not be made by children without supervision.
- If the appliance is fixed wiring, the appliance must be fitted with means for disconnection from the supply mains having a contact separation in all poles that provide full disconnection under over voltage category III conditions, and these means must be incorporated in the fixed wiring in accordance with the wiring rules.
- If the supply cord is damaged, it must be replaced by the manufacturer, its service agent or similarly qualified persons in order to avoid a hazard.
- The appliance shall be installed in accordance with national wiring regulations.
- Servicing shall only be performed as recommended by the equipment manufacturer.
- Maintenance and repair requiring the assistance of other skilled personnel shall be carried out under the supervision of the person competent in the use of flammable refrigerants.

# Refrigerant flow diagram

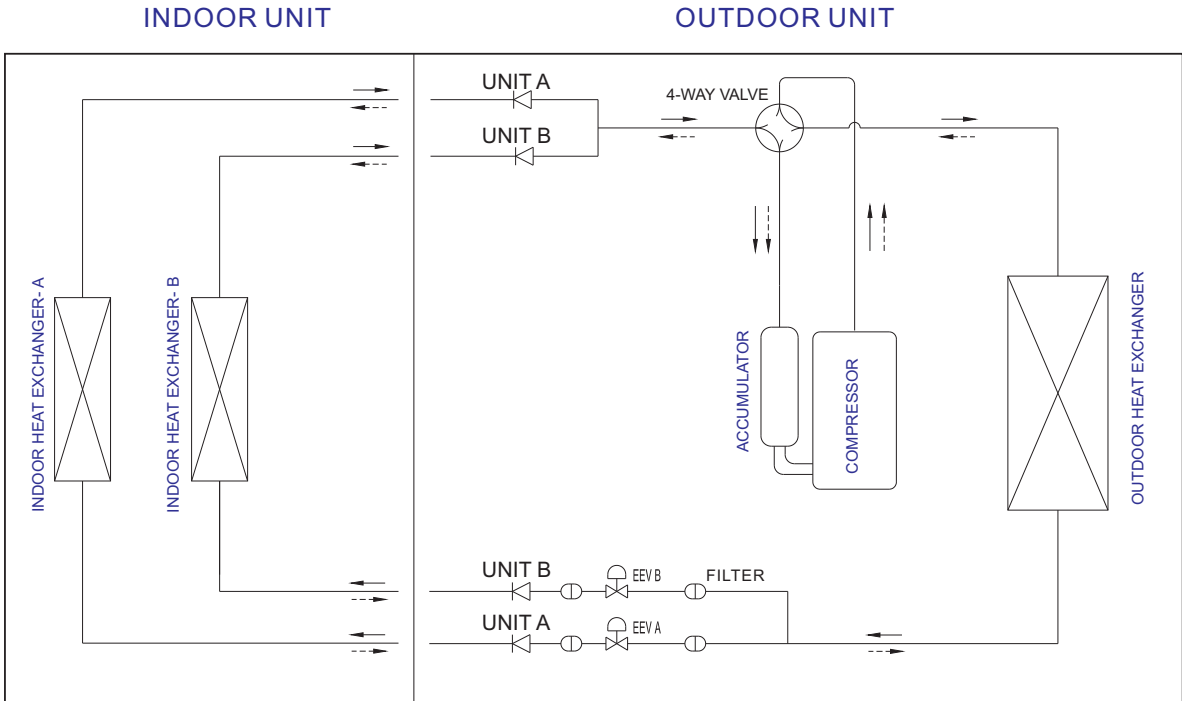

← Cooling cycle

← Heating cycle

# Installation instructions

## Installation diagram

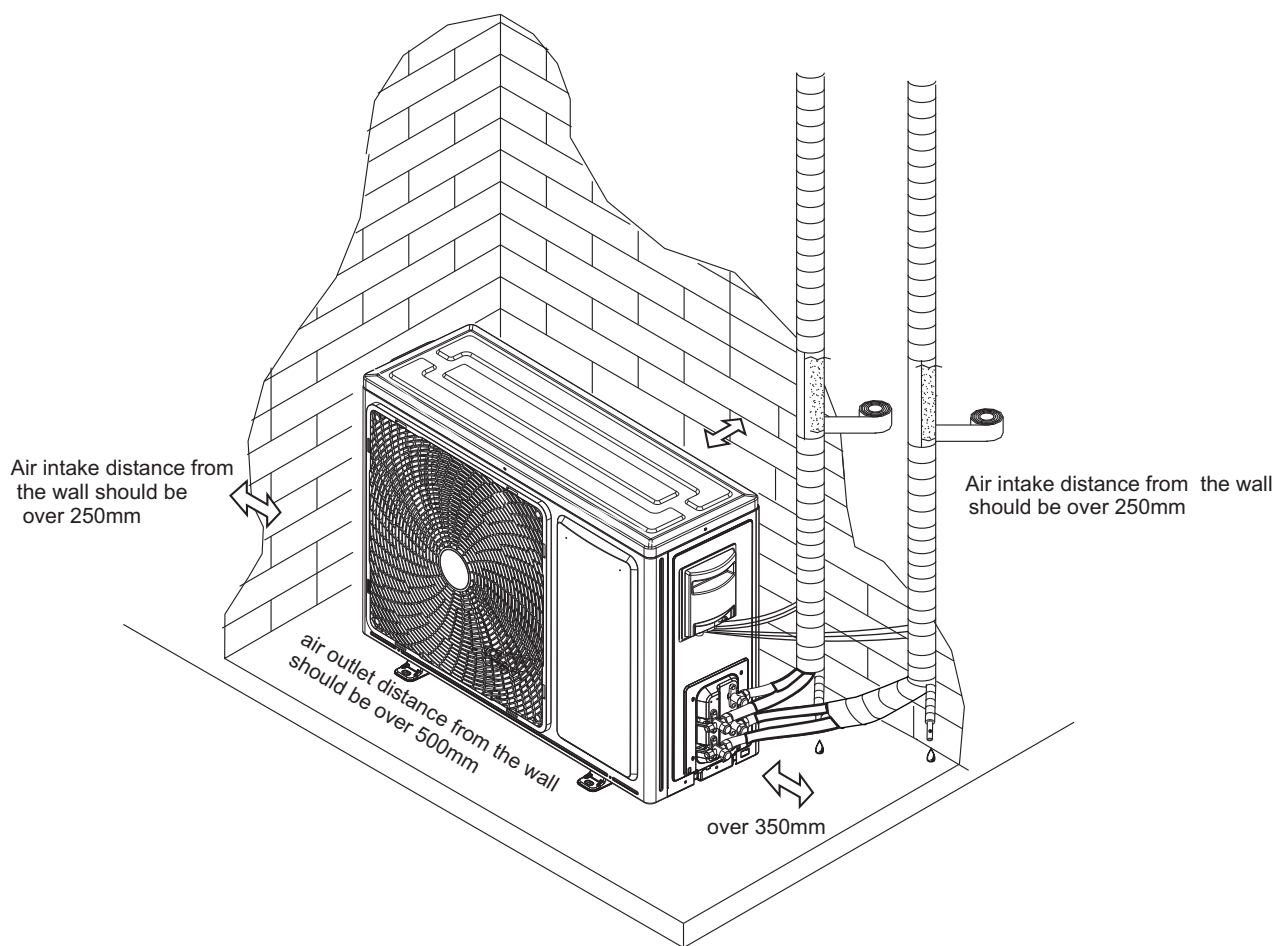

## outdoor unit

- ▣ Above figure is only a simple presentation of the unit, it may not match the external appearance of the unit you purchased.
- Installation must be performed in accordance with the national wiring standards by authorized personnel only.

# Installation instructions

## Transportation and Handling before Installation

Transport the product as close to the installation location as practical before unpacking.

### • Hanging Method

When hanging the unit, ensure a balance of the unit, check safety and lift up smoothly.

- (1) Do not remove any packing materials.
- (2) Hang the unit under packing condition with two ropes, as shown in Fig. blow.

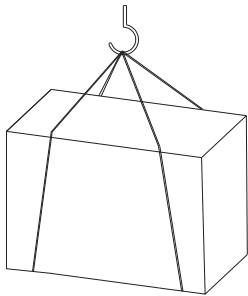

### • Hanging

If have no package to move , Please protect with cloth or paper.

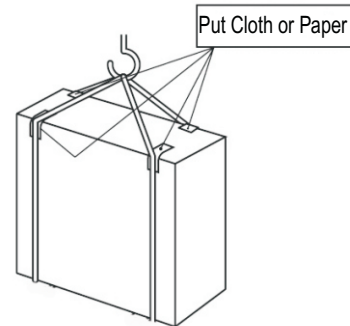

## Select the installation locations

**Before choosing the installation site, obtain user approval.**

- Where it is not exposed to strong wind.
- Where airflow is good and clean.
- Where it is not exposed to rain and direct sunshine.
- Where neighbors are not annoyed by operation sound or hot air.
- Where rigid wall or support is available to prevent the increase of operation sound or vibration.
- Where there is no risk of combustible gas leakage.
- Where it is at least 3m away from the antenna of TV set or radio. An amplifier may be required for the affected device.
- Install the unit horizontally.
- Please install it in an area not affected by snowfall or blowing snow. In areas with heavy snow, please install a canopy, a pedestal and/or some baffle boards.

### ⚠ CAUTION:

Avoid the following places for installation where air conditioner trouble is liable to occur.

- Where there is much machine oil.
- Salty places such as seaside.
- Where sulfide gas is generated such as a hot spring.
- Where there is high-frequency or wireless equipment.

### Note:

When operating the air conditioner in low outside temperature, be sure to follow the instruction describe below.

- Never install the outdoor unit in a place where its air inlet/outlet side may be exposed directly to wind.
- To prevent exposure to wind, install the outdoor unit with its air inlet side facing the wall.
- To prevent exposure to wind, it is recommended to install a baffle board on the air outlet side of the outdoor unit.

## Install drainage elbow and drain hose

### Install Drainage Elbow and Drain Hose

·The condensate water may drains from the outdoor unit when the unit operates in heating mode.In order to avoid disturbing neighbors also to protect the environment, it is necessary to install a drainage elbow and a drain hose to drain out the condensate water.

·Please do the drainage work before the indoor unit and outdoor unit are connected .Otherwise, it will be difficult to install drainage elbow after the machine becomes immovable.)

·Connect the drain hose( filed-supplied, inside diameter: 15mm) as shown in the figure for drainage.

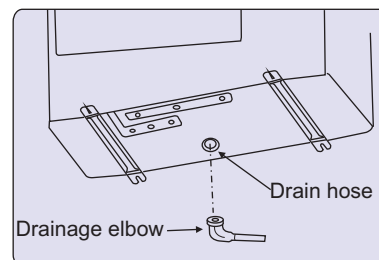

### Note:

Do not use the drain elbow in the cold region. Drain may freeze to stop the fan runs.

# Installation instructions

## Outdoor Installation

### ⚠ NOTE:

- Be sure to fix the unit's legs with bolts when installing it.
- Be sure to install the unit firmly to ensure that it does not fall by earthquake or gust.
- The anchor bolts, nuts and washers for the installation are user prepared.

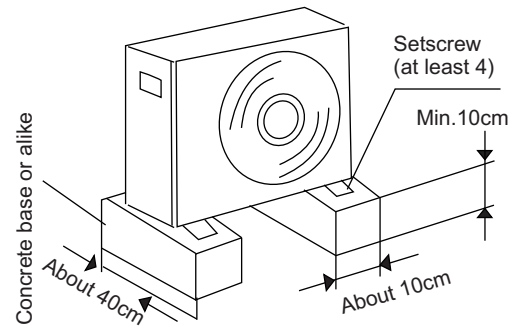
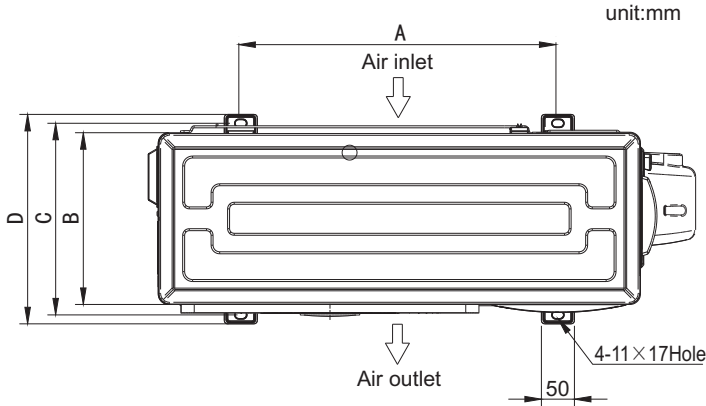

Cooling Capacity(Btu/h)	A	B	C	D
14K	480	260	290	317
18K	510	280	310	338

## Refrigerant Piping

### 1. Piping Requirement

Model	Outer Diameter of Pipe (mm)	
	Gas	Liquid
14K/18K	9.52	6.35

Refrigerant piping is short, the better. So the connecting pipe should be as short as possible.

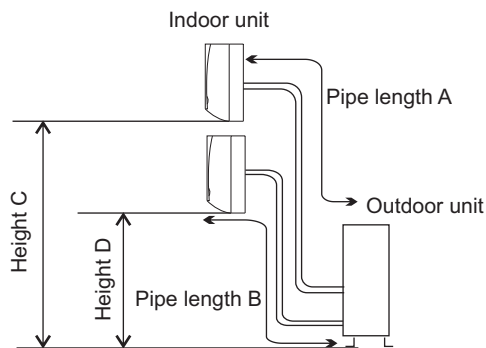

Max Length Between Indoor Unit and Outdoor Unit	m	A ≤ 15 B ≤ 15
Max Length Between Indoor Unit and Outdoor Unit (Total)	m	A+B ≤ 30
Max Height Between Indoor Unit and Outdoor Unit	m	C ≤ 15
Max Height Between Indoor Unit A and Indoor Unit B	m	D ≤ 7.5

### Refrigerant Additional Charge

The unit has been filled with refrigerant, but if L(total pipe length) exceeds 15m, additional refrigerant (R410A) change is required.  
 Additional refrigerant charge = (L-15) × 15g/m

### 2. Piping Requirement

- (1) Prepare locally-supplied copper pipes.
- (2) Select clean copper pipes. Make sure there is no dust and moisture inside of the pipes. Blow the inside of the pipes with nitrogen or dry air, to remove any dust or foreign materials before connecting pipes.



# Installation instructions



(3) Piping thickness and material use the pipe as below.

Diameter	Thickness	Material
φ 6.35	0.8	O
φ 9.52	0.8	O
φ 12.7	0.8	O
φ 15.88	1.0	O

Material is based on a JIS standard (JIS B8607).

**CAUTION**



When installing pipe through the wall, secure a cap at the end of the pipe.

Correct:  Incorrect: 



Hole

Attach a cap or vinyl tape.

Do not place the pipe directly on the ground.

Correct:  Incorrect: 

Attach a cap or vinyl tape.

Correct:  Incorrect: 

Rain water can enter.

Attach a cap or vinyl bag with rubber band.

## 3. Processing of Refrigerant Piping

### (1) Pipe cutting

- Cut the copper pipe correctly with pipe cutter.

### (2) Burrs removal

- Completely remove all burrs from the cut cross section of the pipe.
- Put the end of the copper pipe downward to prevent burrs from dropping in the pipe.

### (3) Putting nut on

- Remove flare nuts attached to indoor and outdoor units, then put them on pipe having completed burr removal.

(Not possible to put them on after flaring work).

- Flare nut for pipe depending on the diameter of pipe.

### (4) Flaring work

- Perform flaring work using flaring tool as shown below.

### (5) Check

- Compare the flared work with the figure below.
- If flare is noted to be defective, cut off the flared section and perform flaring work again.

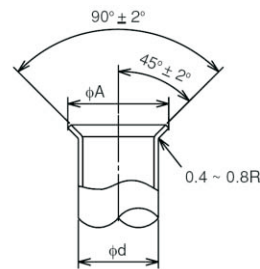

Diameter φd	A <sup>+0</sup> <sub>-0.4</sub>
6.35	9.1
9.52	13.2
12.7	16.6
15.88	19.7

Good:  90°

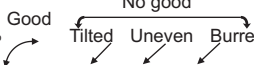
No good: 

Tilted Uneven Burred

Flaring tool

Clutch type 

Wing nut type 

Burr: 

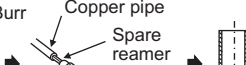
Copper pipe: 

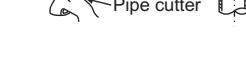
Spare reamer: 

Pipe cutter

Flare nut: 

Copper pipe

Die: 

Copper pipe

Flare nut: 

Copper pipe

Inside is shining without any scratches

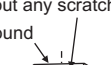
Smooth all around: 

## 4. Piping Connection

(1) Confirm that the valve is closed.

(2) Connect the indoor unit and the outdoor unit with field-supplied refrigerant piping. Suspend the refrigerant piping at certain points and prevent the refrigerant piping from touching the weak part of the building such as wall, ceiling, etc.

(If touched, abnormal sound may occur due to the vibration of the piping.

Pay special attention in case of short piping length.)

(3) Tightening the flare nut use two spanners like figure right.

(4) Apply the refrigerant oil (field-supply) thinly at the seat surface of the flare nut and pipe before connecting and tightening.

And when tightening the flare nut, use two spanners.

(5) Outdoor refrigerant piping should connect with stop valve.

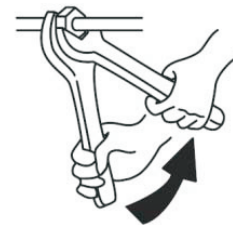

Double Spanner work

Pipe Size	Torque
Φ6.35(1/4)	20N · m (2kgf · m)
Φ9.52(3/8)	40N · m (4kgf · m)
Φ12.7(1/2)	60N · m (6kgf · m)
φ15.88(5/8)	80N · m (8kgf · m)

Tightening Torque for Flare Nut

# Installation instructions

(6) After finishing connecting the refrigerant pipes, keep it warm with the insulation material like figure right.

- For outdoor unit side, surely insulate every piping including valves.
- Cover piping joints with pipe cover.
- Using piping tape, apply taping starting from the entry of outdoor unit. Fix the end of piping tape with adhesive tape.
- Fix the end of piping tape with adhesive tape.
- When piping has to be arranged through above ceiling, closet or area where temperature and humidity are high, wind additional commercially sold insulation for prevention of condensation.

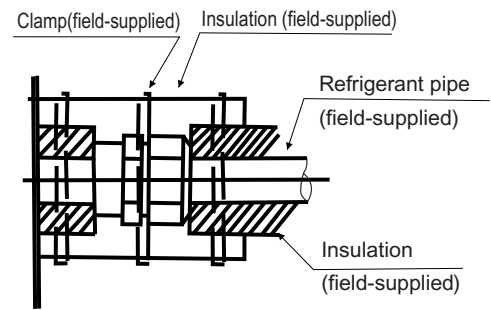

Piping insulation procedure

## 5. Air Tight Test

- Air Tight Check - Do use Nitrogen.

Connect the gauge manifold using charging hoses with a nitrogen cylinder to the check joints of the liquid line and the gas line stop valves. Perform the air-tight test.

Don't open the gas line stop valves.

Apply nitrogen gas pressure of 4.15MPa.

Check for any gas leakage at the flare nut connections, or brazed parts by gas leak detector or foaming agent.

Gas pressure doesn't decrease is OK.

After the air tight test, release nitrogen gas.

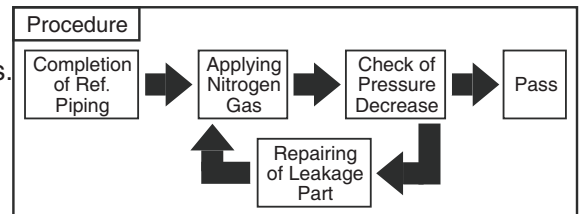

Air tight procedure

## 6 Vacuum Pumping and charge refrigerant

- Vacuum Pumping

- (1) Remove the service port cap of the stop valve on the gas pipe side of the outdoor unit.
- (2) Connect the manifold gauge and vacuum pump to the service port of the stop valve on the gas pipe side of the outdoor unit.
- (3) Run the vacuum pump. (Work for more than 15 minutes.)
- (4) Check the vacuum with the gauge manifold valve, then close the gauge manifold valve and stop the vacuum pump.
- (5) Leave it as is for one or two minutes. Make sure the pointer of the manifold gauge remains in the same position. Confirm that the pressure gauge shows -0.101MPa (or -760mmHg).
- (6) Remove the manifold gauge quickly from the service port of the stop valve.
- (7) After refrigerant pipes are connected and evacuated, fully open all stop valves on both sides of gas pipe and liquid pipe.
- (8) Open adjusted valve to add refrigerant (must be refrigerant is liquid).
- (9) Tighten the cap to the service port.
- (10) Retighten the cap.
- (11) Leak test foam with halogen leak detector to check the flare nut and brazing Carolina Department leaks. Use foam that not generate ammonia (NH<sub>3</sub>) in the reaction.

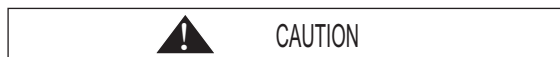
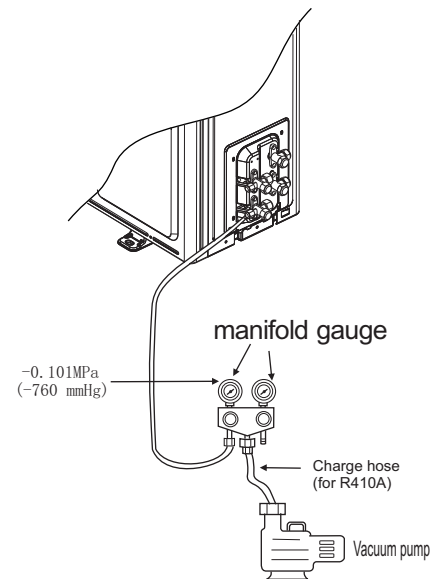

- Each pipelines needs to be evacuated individually.
- An excess or a shortage of refrigerant is the main cause of trouble to the unit. Charge the correct refrigerant quantity according to the description of label at the inside of the manual.
- Check for refrigerant leakage in detail. If a large refrigerant leakage occurs, it will cause difficulty with breathing or harmful gases would occur if a fire was being used in the room.

# Installation instructions

## ● Additional refrigerant charge

The unit has been filled with refrigerant.

Please according "Piping Requirement" to calculate additional charge.

After vacuum pump procedure has been finished, first exhaust air from charge hose, then open valves, charge refrigerant as "liquid" type through Liquid stop valve.

At the end, please close valves and record the refrigerant charging quantity.

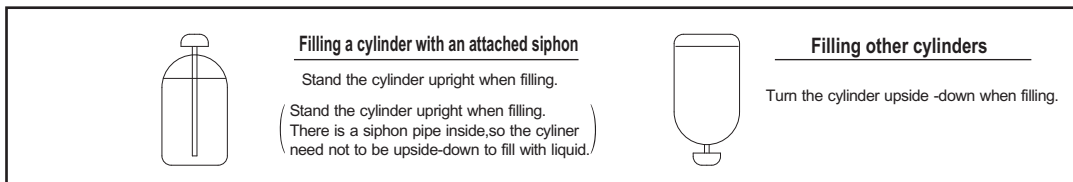

## Wiring



### WARNING

- Turn OFF the main power switch to the indoor unit and the outdoor unit and wait for more than 3 minutes before electrical wiring work or a periodical check is performed.
- Check to ensure that the indoor fan and the outdoor fan have stopped before electrical wiring work or a periodical check is performed.
- Protect the wires, electrical parts, etc. from rats or other small animals. If not protected, rats may gnaw at unprotected parts and at the worst, a fire will occur.
- Avoid the wirings from touching the refrigerant pipes, plate edges and electrical parts inside the unit.  
If not do, the wires will be damaged and at the worst, a fire will occur.
- Install an ELB (Electric Leakage Break) in the power source.  
If ELB is not used, it will cause electric shock or fire at the worst.
- This unit uses an inverter, which means that it must be used an earth leak detector capable handling harmonics in order to prevent malfunctioning of the earth leak detector itself.
- Do not use intermediate connection wires, stranded wires (see **<Attentions when Connect the power supply wiring>**), extension cables or control line connection, because the use of these wires may cause fever, electric shock or fire.
- The tightening torque of each screw shall be as follows.
  - M4: 1.0 to 1.3 N-m
  - M5: 2.0 to 2.5 N-m
  - M6: 4.0 to 5.0 N-m
  - M8: 9.0 to 11.0 N-m
  - M10: 18.0 to 23.0 N-mKeep the above tightening torque when wiring work.



### CAUTION

- With tape material along the wire wrapped, sealed wiring holes, prevent the condensed water and insects.
  - Tightly secure the power source wiring using the cord clamp inside the unit.
- Note: Fix the rubber bushes with adhesive when conduit tubes to the outdoor unit are not used.

### General Check

- (1) Make sure that the field-selected electrical components (main power switches, circuit breakers, wires, conduit connectors and wire terminals) have been properly selected according to the electrical data.  
Make sure that the components comply with National Electrical Code (NEC).
- (2) Check to ensure that the voltage of power supply is within +10% of nominal voltage and earth phase is contained in the power supply wires. If not, electrical parts will be damaged.
- (3) Check to ensure that the capacity of power supply is enough.  
If not, the compressor will be not able to operate cause of voltage drop abnormally at starting.
- (4) Check to ensure that the earth wire is connected.
- (5) Install a main switch, multi-pole main switch with a space of 3.5mm or more, single phase main switch with a space of 3.0mm or more between each phase. Please use the special three-phase power switch for 3-Phase product.
- (6) Check to ensure that the electrical resistance is more than 2 MΩ, by measuring the resistance between ground and the terminal of the electrical parts.  
If not, do not operate the system until the electrical leakage is found and repaired.

# Installation instructions

## Electrical wiring diagram

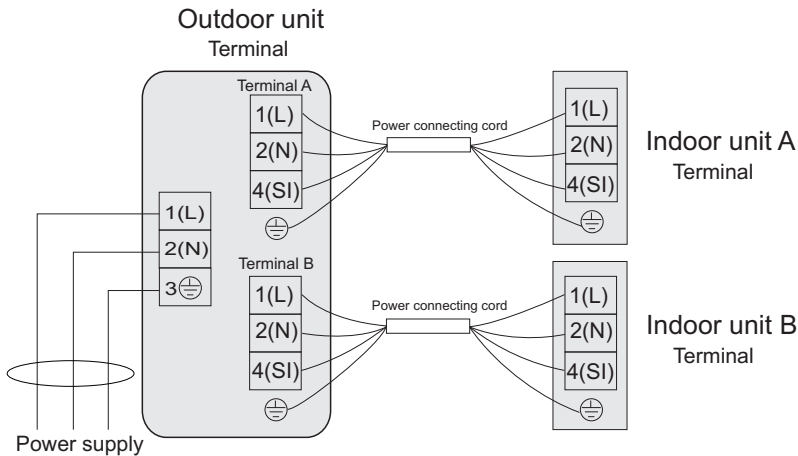

Note: For some indoor units

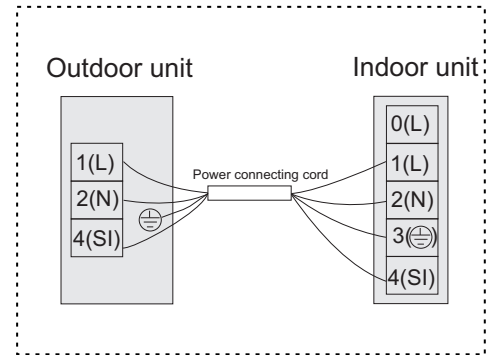

## Electrical Data

Power Supply	ELB		Power Source Cable Size	Transmitting Cable Size
	Rated Current(A)	Nominal Sensitive Current(mA)	En60 335-1*1	EN60 335-1*1
220-240V ~50Hz	40	30	3×1.5mm <sup>2</sup>	4×1.5mm <sup>2</sup>

Max. Running Current(A): REFER TO NAMEPLATE

Note:

- (1) Follow local codes and regulations when select field wires ,and all the above are the minimum wire size.
- (2) Use the wires which are not lighter than the ordinary polychloroprene sheathed flexible cord.(Cord designation H07RN-F).
- (3) The wire sizes marked with \*1 in the above table are selected at the maximum current of the unit according to the European Standard,EN60 335-1.
- (4) Install main switch and ELB for each system separately. Select the high response type ELB that is acted within 0.1second.

Recommended capacity to see outdoor machine switch capacity.

In the case that power cables are connected in series, add each unit maximum current and select wires below.

### Selection According to EN60335-1

Current i (A)	Wire Size (mm <sup>2</sup> )
$i \leq 6$	0.75
$6 < i \leq 10$	1
$10 < i \leq 16$	1.5
$16 < i \leq 25$	2.5
$25 < i \leq 32$	4
$32 < i \leq 40$	6
$40 < i \leq 63$	10
$63 < i$	*

\*in the case that current exceeds 63A, do not connect cables in series.

### <Attentions when Connect the power supply wiring>

1. When connecting the terminal block using stranded wire, make sure to use the round crimp-style terminal for connection to the power supply terminal block. Place the round crimp-style terminals on the wires up to the covered part and secure in place.

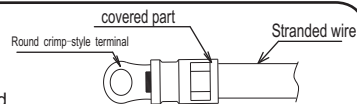

2. When connecting the terminal block using a single core wire, be sure to perform curing.

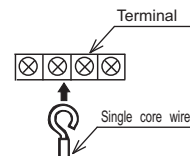

# Installation instructions

## Trial Run

Trial run should be performed after refrigerant piping, drain, wiring, etc. have been finished.



The air-conditioner is provided with a crankcase heater, check to ensure that the switch on the main power source has been ON for more than 6 hours ahead of power on preheating, otherwise it might damage the compressor!

Do not operate the system until all the check points have been cleared.

- ( A ) Check to ensure that the stop valves of the outdoor unit are fully opened.
- ( B ) Check to ensure the electric wires has been fully connected.
- ( C ) Check to ensure that the electrical resistance is more than 2 megohm, by measuring the resistance between ground and the terminal of the electrical parts. If not, do not operate the system until the electrical leakage is found and repaired.

Trial run function identification

Operate remote controller turn ON, then proceed trial run.

Pay attention to the following items while the system is running.

Do not touch any of the parts by hand at the discharge gas side, since the compressor chamber and the pipes at the discharge side are heated higher than 90°C.

- Turn off the power after trial run is finished.  
Installation of the appliance is generally finished after the above operations are done. If you still have any trouble, please contact local technical service center of our company for further information.



#### Correct Disposal of this product

This marking indicates that this product should not be disposed with other household wastes throughout the EU. To prevent possible harm to the environment or human health from uncontrolled waste disposal, recycle it responsibly to promote the sustainable reuse of material resources. To return your used device, please use the return and collection systems or contact the retailer where the product was purchased. They can take this product for environmental safe recycling.